

# Small World

Whale 6/6

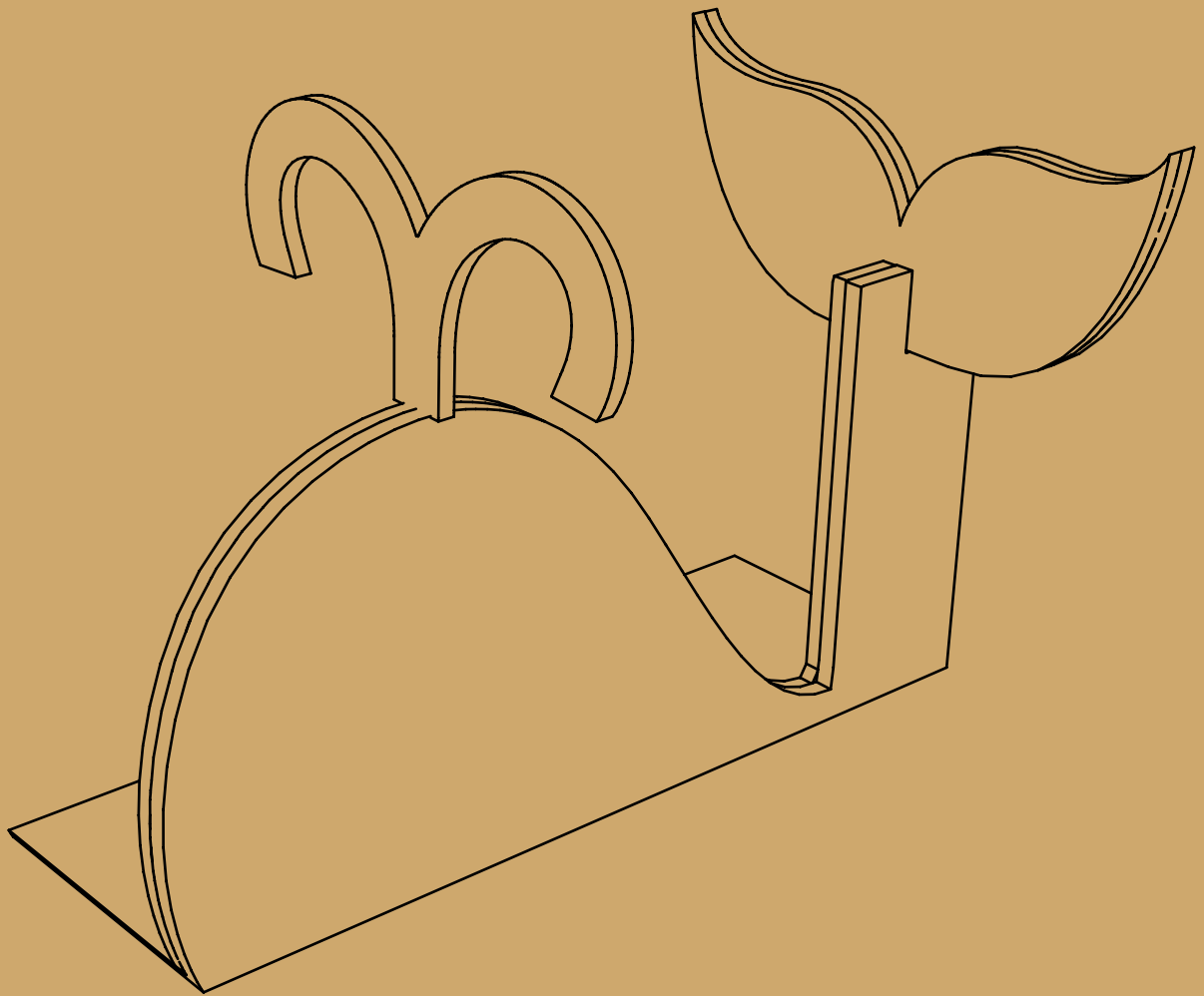

# Turn any used box into a whale

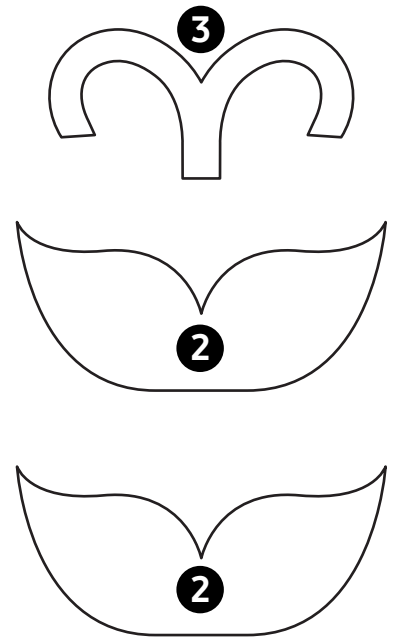
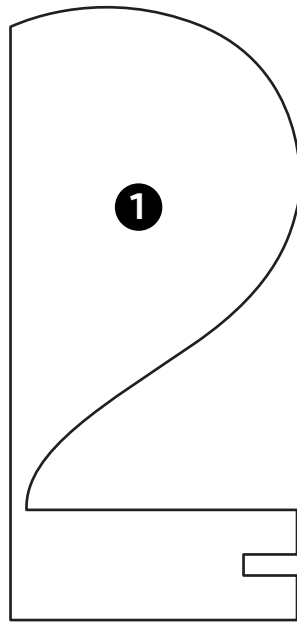
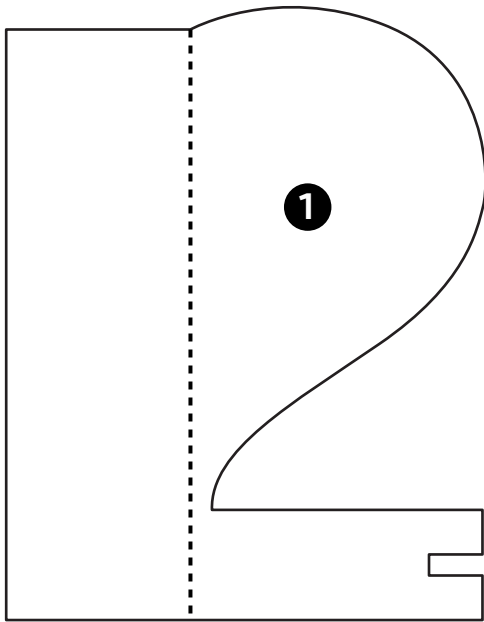

1

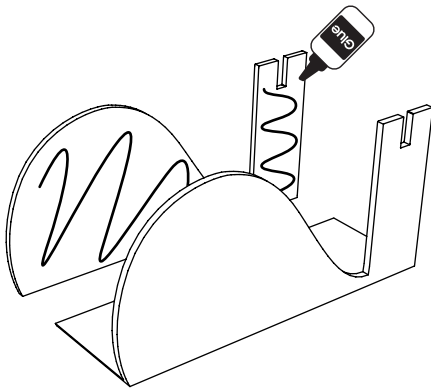

Glue the whale body together.

2

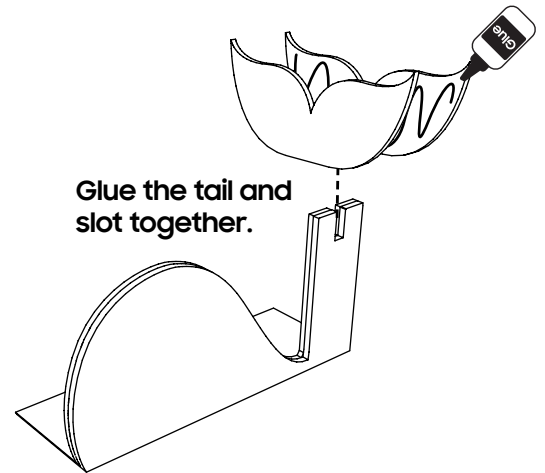

Glue the tail and slot together.

3

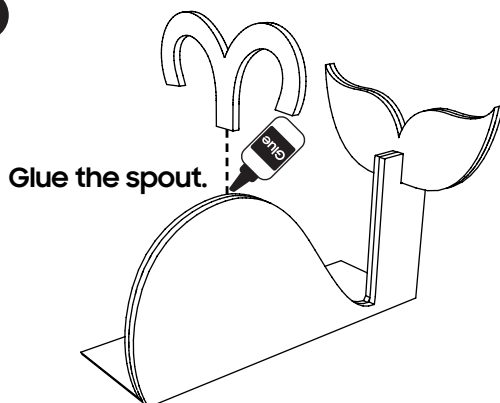

Glue the spout.

4

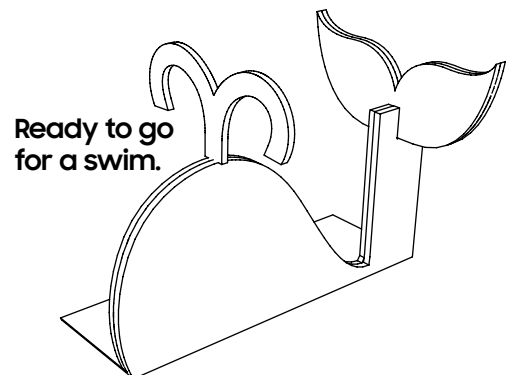

Ready to go for a swim.

Turn any used box  
into a whale

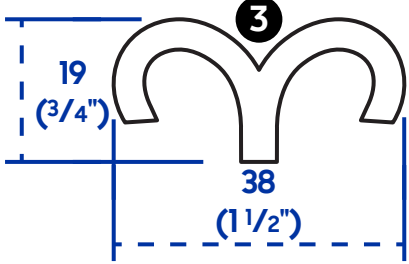
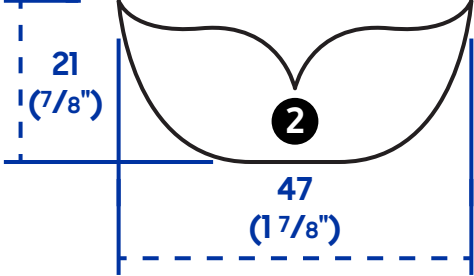
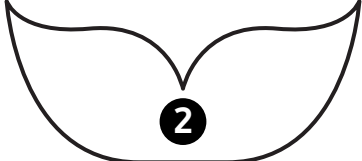
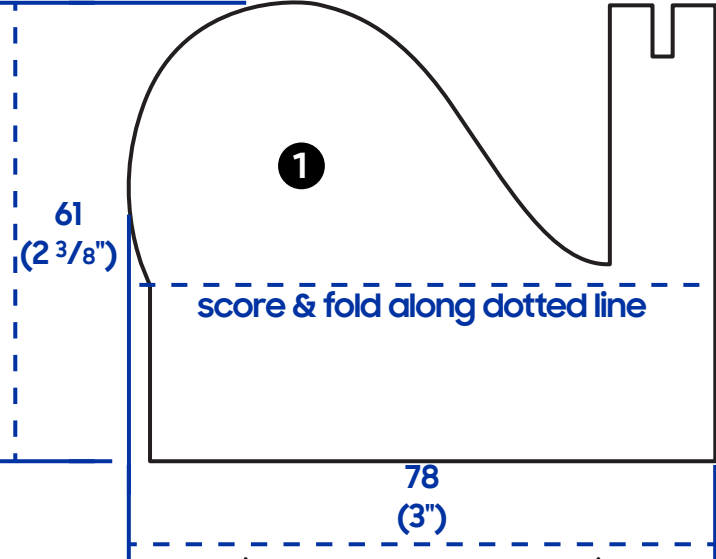
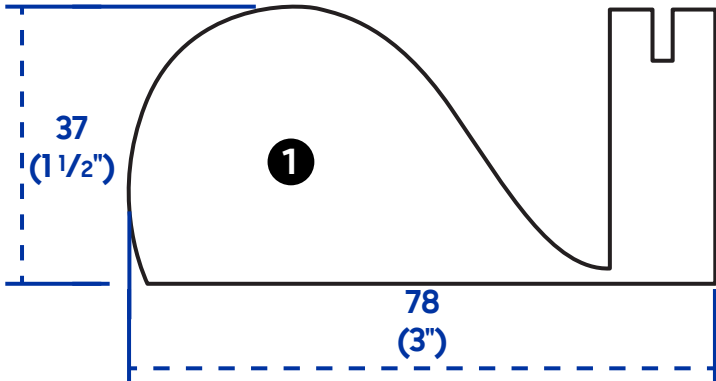

# Create your Small World

Find more Small World design blueprints at [TheSmallWorldCollection.com](http://TheSmallWorldCollection.com)

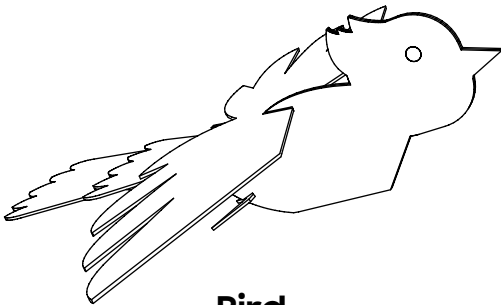

**Bird**

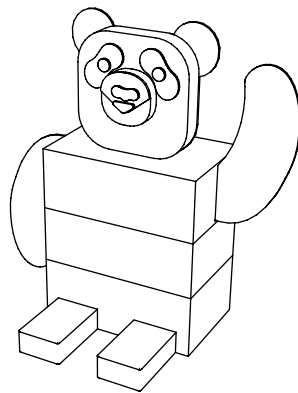

**Panda**

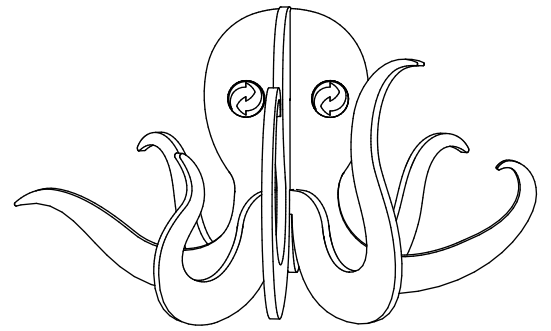

**Octopus**

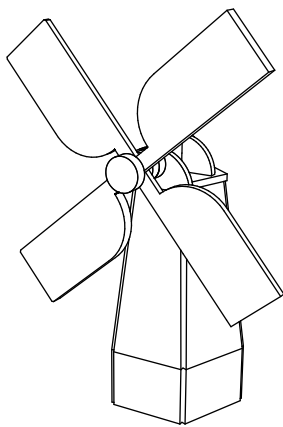

**Windmill**

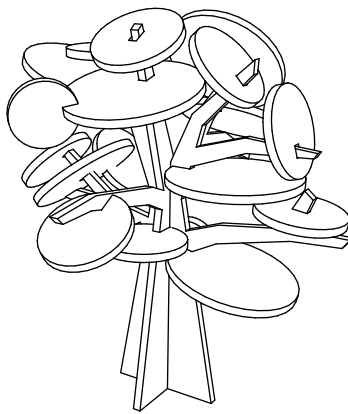

**Cherry Blossom Tree**

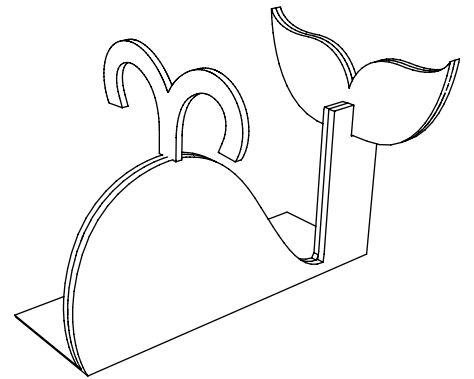

**Whale**